

BASO 2.5 DIRECT

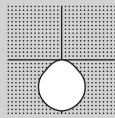

PERFORMANCE

- Up to 106lm/W efficiency
- 455 / 750lm/ft
- CRI > 80 & CRI > 90
- Damp rated



MOUNTING

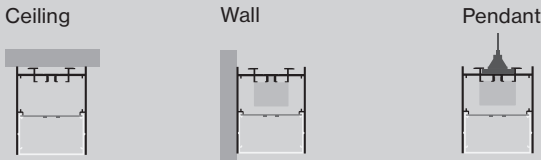

PATTERNS

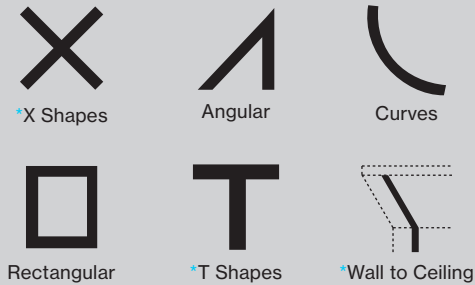

For customization, please contact customer service

FIELD-CUTTABLE FLEX

Down to 1/16"



[link to video](#)

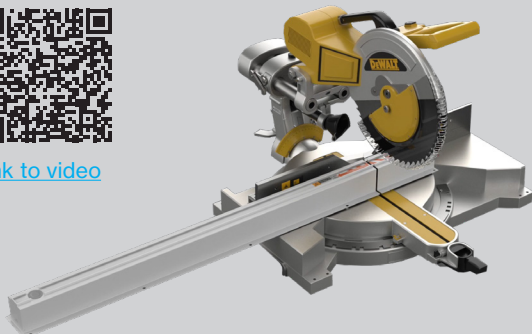

Catalog Number Example

BASO 2.5-SUR-BL-LBM-OP-30K-C80-UNV-010V-SEN-455LF-NLC-ST-96IN

A RANGE

BASO 2.5 BASO 2 . 5

B MOUNTING

CS Surface	SUR
Surface in-line ACT T-BAR	SAT
Surface in-line ACT SLOT	SAS
Surface ACT center tile	SAC
CS Pendant	PDT
Pendant in-line ACT T-BAR	PAT
Pendant in-line ACT SLOT	PAS
Pendant ACT center tile	PAC

pendant suspension set includes cable suspension and one white power feeder with a white junction box cover

Wall mounted WAL

for black power feeds or junction box covers, please contact customer service

C COLOR

CS White	WH
CS Black	BL
Gray	GR
Custom color RAL	XX

trimless version available in white only

D LENS

HP opal cover OP

E CCT

2700K	27K
CS 3000K	30K
CS 3500K	35K
4000K	40K

F CRI

CRI > 80	C80
CRI > 90	C90

G VOLTAGE

120V / 277V UNV

H DIMMING

CS 0-10V 1%	010V
Lutron EcoSystem	LES1
Quantum, Vive, GRAFIK Eye, HomeWorks	
Power over ethernet	POEC
consult customer service for compatibility	
Custom dimming	XXXX
consult customer service for compatibility	

I SENSOR (optional)

Integrated Sensor SEN
consult customer service for sensor request

J OUTPUT LM/FT

CS 500lm/ft 100% ↓	0500LF
CS 750lm/ft 100% ↓	0750LF
CS 1000lm/ft 100% ↓	1000LF
Custom lm/ft	XXXXLF

custom lumen up to 1200 lm/ft

K CIRCUIT / EM

CS Single circuit	*
EMC night light circuit	NLC
EMB available in 4ft and 8ft	EM#

* leave blank

L SHAPE / PATTERN

CS Linear / straight	ST
CS Linear / straight + flex inset	SF
includes 1ft. field-cuttable section; only available for 4' and 8' segments	
L-shape	LS
□-shape (rectangular shape)	RS
U-shape	US
Custom shape	XX

M DIMENSIONS IN INCH

Linear 2'	24IN
CS Linear 4'	48IN
CS Linear 6'	72IN
CS Linear 8'	96IN
Linear custom	###IN
Linear flex inset	###IN
includes 4' to 3' field-cuttable section	
L-Shape	###X###IN
U-Shape	###X###X###IN
□-Shape	###X###IN

for curved options, please see our SHAPES brochure



for lengths including flex insets, round up to the nearest **total** foot length

N CERTIFICATION (optional)

Red List Approved DRLA

BASO
basolighting.com
xalusa.com

Technical data

	SIZE TYPE	LED COLOR TEMPERATURE	INPUT WATTS	DELIVERED LM TOTAL	LIGHT DISTRIBUTION	DELIVERED LM DIRECT	DELIVERED LM INDIRECT	OPTICAL EFFICIENCY	LUMINAIRE EFFICACY	
BASO DIRECT										
	e LED	2' linear	40K	8.7W	910lm	100% down	455lm/ft	-	74%	106lm/W
		4' linear		17.5W	1820lm					
		6' linear		25.8W	2740lm					
		8' linear		34.4W	3650lm					
		2' + 2' corner		17.5W	1820lm					
	e² LED	2' linear	40K	14.7W	1500lm	100% down	750lm/ft	-	74%	102lm/W
		4' linear		29.5W	3010lm					
		6' linear		44.2W	4510lm					
		8' linear		59W	6020lm					
		2' + 2' corner		29.5W	3010lm					

for 30K or 35K multiply lm value by 0.96

Patterns top view

LINEAR

A	FIXTURES	CODE
48"	1 x 4' linear	ST - 0 4 FT
96"	1 x 8' linear	ST - 0 8 FT
144"	3 x 4' linear	ST - 1 2 FT

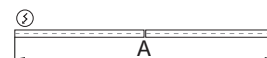

L-SHAPE

A / B	FIXTURES	CODE
48" / 48"	2 x 2' linear + 1 x 2' x 2' corner	LS - 0 4 X 0 4 FT
48" / 96"	1 x 2' linear + 1 x 6' linear + 1 x 2' x 2' corner	LS - 0 4 X 0 8 FT
96" / 96"	2 x 6' linear + 1 x 2' x 2' corner	LS - 0 8 X 0 8 FT

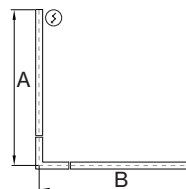

□-SHAPE (rectangular shape)

A / B	FIXTURES	CODE
48" / 48"	4 x 2' x 2' corner	RS - 0 4 X 0 4 FT
48" / 96"	2 x 4' linear + 4 x 2' x 2' corner	RS - 0 4 X 0 8 FT
96" / 96"	4 x 4' linear + 4 x 2' x 2' corner	RS - 0 8 X 0 8 FT

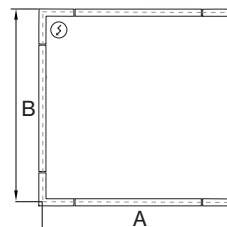

U-SHAPE

A / B / C	FIXTURES	CODE
48" / 48" / 48"	2 x 2' linear + 2 x 2' x 2' corner	US - 0 4 X 0 4 X 0 4 FT
48" / 96" / 48"	1 x 4' linear + 2 x 2' linear + 2 x 2' x 2' corner	US - 0 4 X 0 8 X 0 4 FT
48" / 144" / 48"	1 x 8' linear + 2 x 2' linear + 2 x 2' x 2' corner	US - 0 4 X 1 2 X 0 4 FT

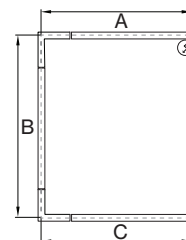

DIMENSIONS

BASO 2.5

SURFACE
direct

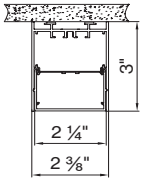

linear 4ft / 8ft

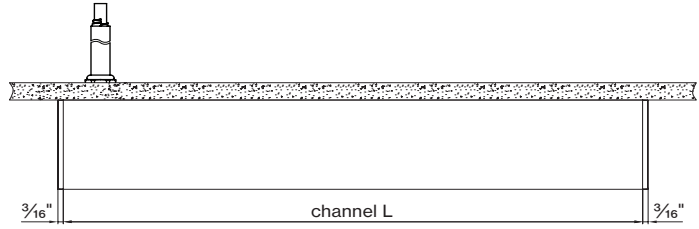

PENDANT
direct

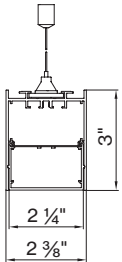

direct / indirect

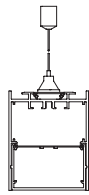

linear 4ft / 8ft

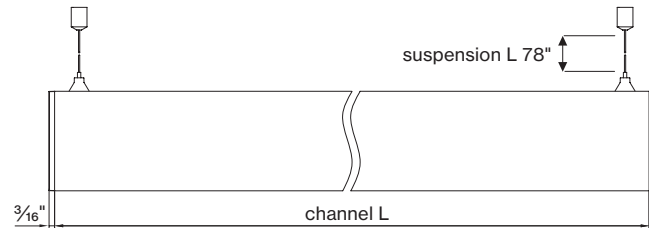

BASO 2.5 SPECIALITY MOUNTING

SURFACE
in-line ACT TBAR

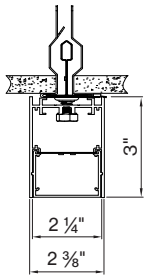

SURFACE
in-line ACT SLOT

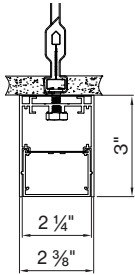

SURFACE
ACT center tile

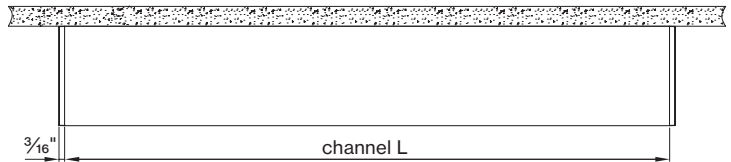
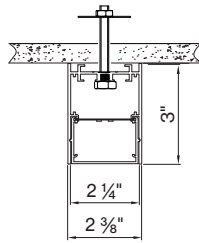

PENDANT
ACT TBAR

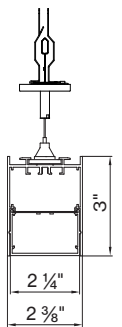

PENDANT
in-line ACT SLOT

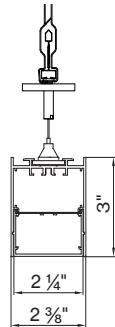

PENDANT
ACT center tile

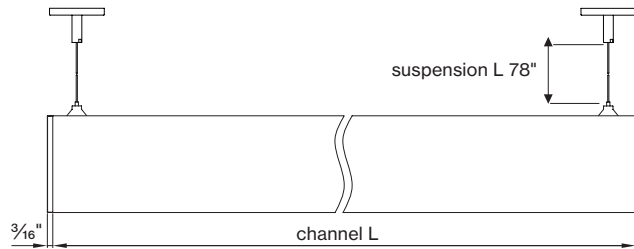
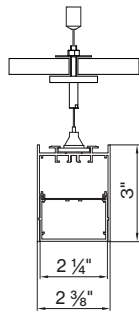

Declare.

BASO 1.2 2.5 4.0
XAL USA Incorporated
10000 Westpark Drive
Houston, TX 77036
www.xalusa.com
© 2024 Xal USA Incorporated
All rights reserved. Xal USA Incorporated is not responsible for any damage or injury caused by the use of the product. Xal USA Incorporated is not responsible for any damage or injury caused by the use of the product. Xal USA Incorporated is not responsible for any damage or injury caused by the use of the product.

BASO mounting instructions

Get access to the BASO 2.5 mounting instructions faster by scanning the QR code.

www.xalusa.com/resources/mounting-instructions/baso

